

Innovative Products that Power Greater Manufacturing Productivity,
Set-Up Efficiencies and Operating Cost Reductions

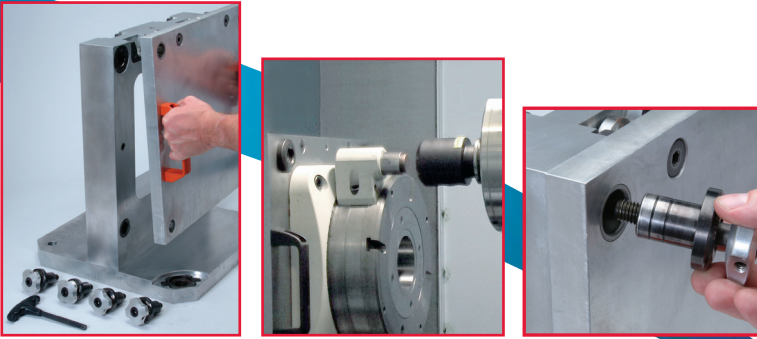



PRODUCTS BY MODERN INDUSTRIES

The name stands for "maximizing the power" ...the **POWER** to create a significant competitive edge in both manufacturing throughput and cost reductions using your current equipment.

The advanced technology engineered into the **mPower™** line of integrated workholding products offers you numerous exclusive benefits...

- The power to make set-up and fixture changes in just seconds
- Unequalled workholding flexibility
- Optimized machining throughput
- Maximize your competitive edge by reducing operating costs.

Finally. An integrated workholding system consisting of the **SpeedLoc™** mounting system, **ModLoc™** modular tooling columns and **SpinLoc™** indexers capable of actually improving productivity and increasing bottom line profitability.



Quick Change Fixturing

The patent pending **SpeedLoc™** system gives you the best of super fast installation and precision location.

This totally unique, highly precise fixturing/mounting system is the key to the countless benefits which the **mPower™** line of integrated workholding products offers you.

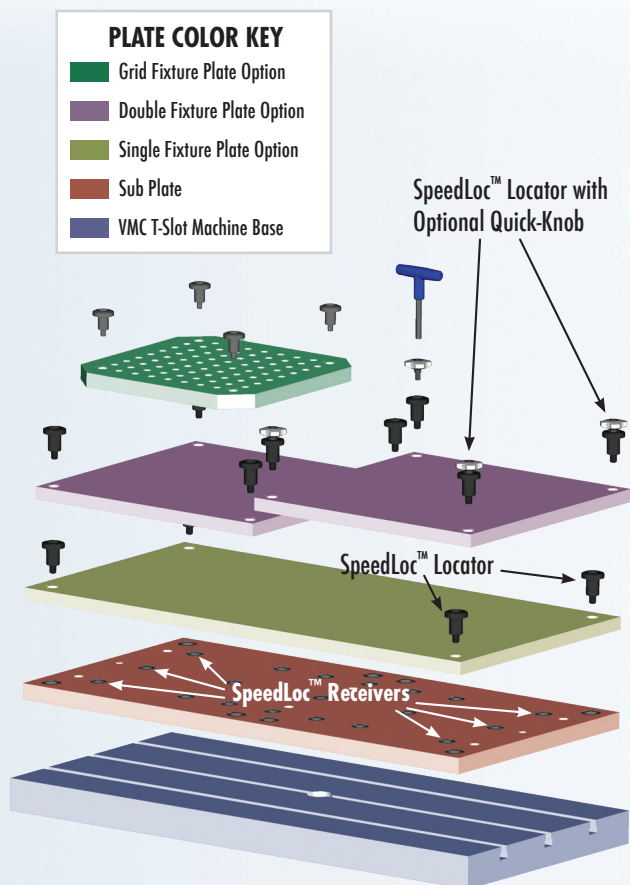

The **SpeedLoc™** Fixturing/Mounting System

Consider these exclusive **SpeedLoc™** features...

- **Precision** – repeatability and accuracy within .0004" or better.
- **Self-Extracting** – no binding or prying fixture and base plates apart.
- **Compact Design**
- **Recessed/Flush Mount** capability.
- **Retrofittable** – with competitive systems.
- **Holding/Clamping Strength** – to 45,000 lbs.
- **Ease of Use** – compared to shoulder bolts and dowel pins.

Mod LOC™ Modular Tooling Columns

Meet the tooling columns that are the fusion of science & nature.

No other tooling column compares...the patented **ModLoc™** fuses advanced structural engineering with the strength of exoskeletons to produce a revolution in tooling column design & performance.

Consider these unique **ModLoc™** tooling column features:

- **"Kit" Construction** – enables incredibly quick assembly.
- **Build Your Own Columns** – faster, more accurate, and less expensive.
- **Open Architecture** – easily accommodates hydraulic & electrical systems.
- **Serialized Sets** – uniquely manufactured to ensure best-fit accuracy.
- **Rigid, Yet Lightweight** – high strength design, yet reduced overall weight.
- **Strength & Rigidity** – comparable to cast tombstones.

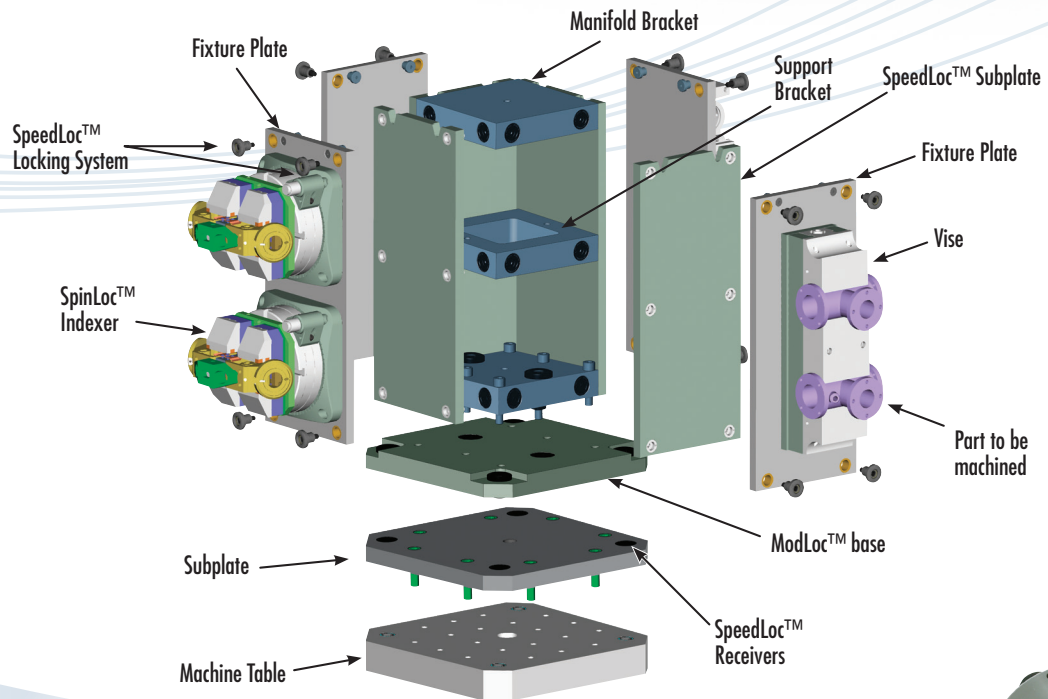

Spin LOC™ Indexers

Numerous devices are available today to help you create 4th or 5th axis machining capabilities. However, no system compares to the range of features, benefits and significant operating advantages delivered by unique, patented **SpinLoc™** Indexers.

- **Simplicity** – **SpinLoc™** indexers are mechanically actuated by the machine tool, eliminating the need for electronic or hydraulic systems.
- **Low Cost Operation** – **SpinLoc™** Indexers are significantly less costly to operate versus typical "power-driven" indexers.
- **Faster Set-Up & Integration** – **SpinLoc™** indexers can be integrated into fixturing systems much faster than powered systems.
- **Multiple Actuation Options** – Rotary and Plunger activated models available.





Precision Fixture Mounting System

Standard or Flush Mount



SpeedLoc™ Precision Mounting System

Product overview:

No mounting system available today for tooling/workholding equipment compares to the speed, ease of installation and precise repeatability offered by the patent pending **SpeedLoc™** precision mounting system.

This unique two part system consists of a highly precise "locator" and "receiver" which when "locked" in place by its cap screw locking device, can create a holding strength exceeding 45,000 lbs.

Applications:

- HMC, VMC, and CNC Turning Machines
- Fixturing
- Workholding
- Automation Systems
- Plastic Molding Equipment
- Welding and Fabrication
- Assembly/Production Equipment
- Transfer Lines
- Pressure Vessels

Anywhere you need fast, precise locating and fastening in repeated use applications.

How it Works

You'll find installation or disassembly of the **SpeedLoc™** "locator" and "receiver" incredibly fast and convenient.

<p>STEP 1 Time: 5 sec.</p> <p>Place fixture plate over sub-plate or machine table containing SpeedLoc™ receivers. For horizontal applications use the patent pending SpeedLoc™ fixture plate docking system.</p>	
<p>STEP 2 Time: 5 sec.</p> <p>Insert the SpeedLoc™ precision locators through holes lined with hardened bushings and into the receiver pockets.</p>	
<p>STEP 3 Time: 25 sec.</p> <p>Insert remaining locators into unlined holes and hand tighten with an Allen wrench or use the exclusive SpeedLoc™ Quick-Knob.</p>	
<p>STEP 4 Time: 15 sec.</p> <p>Torque as required.</p>	
<p>STEP 5</p> <p>Ready to begin machining.</p> <p>Total time required to unload existing fixture plate and load a new plate is 100 sec.</p>	

See **SpeedLoc™** in Action

Visit www.mpwer.com



www.mpwer.com

Locator Unit

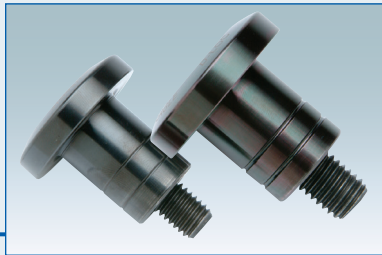

Features:

- **Easy Locating**...installs and locks in seconds.
- Offers +/- .0004" accuracy in workholding.
- **Self-Extracting**...the unique design of the **SpeedLoc™** system enables it to easily and quickly "self-extract" from fixture plates, etc., without binding or hang-ups.
 - » The exclusive self-extracting mechanism **eliminates** the need for prying, pounding or using jack screws to separate fixture and base plates.
 - » The **SpeedLoc™** self-extracting feature also enables it to be easily removed from counterbored installations.

» The quick disassembly feature also **eliminates** binding problems which can compromise alignment accuracy, damage fixturing and increase downtime due to lengthy change-outs.

- **Clamping Strength**...to 45,000 lbs...stronger than competitive systems, which are prone to leaking in tooling columns outfitted for hydraulic systems.

Compact/Flush Mount Design Option

- **Locator head lies flush**... with the fixture plate surface.
- Proudly made in the USA.
- No repair kits needed.

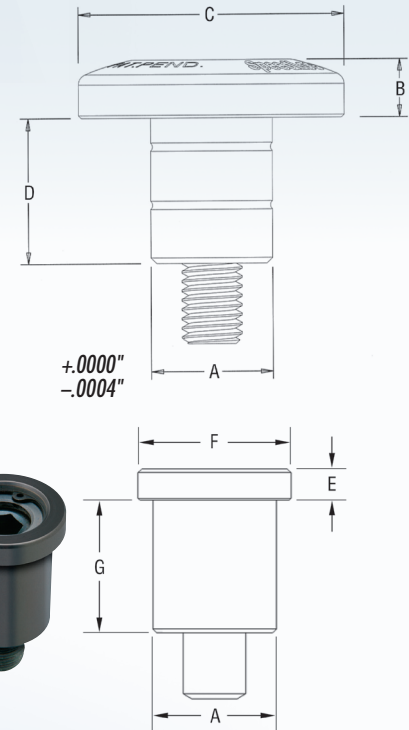

U.S. PATENT 7,686,553

MATERIAL: HEAT TREATED HIGH STRENGTH ALLOY STEEL

STRENGTH: 180,000+ PSI

FINISH: BLACK OXIDE

Stainless and high-temperature steels available in all sizes at special request.

FIXTURE PLATE THICKNESS +/- .005 (inch)	STANDARD LOCATOR PART NUMBER	COMPACT/FLUSH MOUNT LOCATOR PART NUMBER	SHANK DIAMETER (mm) A	HEAD THICKNESS (inch) B	HEAD DIAMETER (inch) C	STD. SHANK LENGTH (inch) D	MAX. HOLD DOWN FORCE (lbs)	SCREW SIZE	COMPACT/ FL. HEAD THICKNESS (inch) E	COMPACT/ FL. HEAD DIAMETER (inch) F	COMPACT/ FL. SHANK LENGTH (inch) G
.50	AS-13001	AS-13010	13	.250	1.000	.780	2964	1/4-20	.175	.635	.587
.75	AS-13002	AS-13011	13	.250	1.000	1.030	2964	1/4-20	.175	.635	.837
.50	AS-16001	AS-16010	16	.312	1.375	.780	5385	5/16-18	.175	.786	.587
.75	AS-16002	AS-16011	16	.312	1.375	1.030	5385	5/16-18	.175	.786	.837
1.00	AS-16003	AS-16012	16	.312	1.375	1.280	5385	5/16-18	.175	.786	1.087
.75	AS-20001	AS-20010	20	.375	1.625	1.070	8107	3/8-16	.250	.975	.800
1.00	AS-20002	AS-20011	20	.375	1.625	1.320	8107	3/8-16	.250	.975	1.050
1.50	AS-20003	AS-20013	20	.375	1.625	1.820	8107	3/8-16	.250	.975	1.550
2.00	AS-20004	AS-20014	20	.375	1.625	2.320	8107	3/8-16	.250	.975	2.050
.75	AS-25001	AS-25010	25	.406	1.800	1.065	14709	1/2-13	.250	1.218	.800
1.00	AS-25002	AS-25011	25	.406	1.800	1.315	14709	1/2-13	.250	1.218	1.050
1.50	AS-25005	AS-25013	25	.406	1.800	1.815	14709	1/2-13	.250	1.218	1.550
2.00	AS-25004	AS-25014	25	.406	1.800	2.315	14709	1/2-13	.250	1.218	2.050
.75	AS-30001	AS-30010	30	.500	2.125	1.150	22623	5/8-11	.312	1.500	.825
1.00	AS-30002	AS-30011	30	.500	2.125	1.400	22623	5/8-11	.312	1.500	1.075
1.50	AS-30003	AS-30013	30	.500	2.125	1.900	22623	5/8-11	.312	1.500	1.575
2.00	AS-30004	AS-30014	30	.500	2.125	2.400	22623	5/8-11	.312	1.500	2.075
.75	AS-35001		35	.500	2.250	1.150	31572	3/4-10			
1.00	AS-35002	AS-35010	35	.500	2.250	1.400	31572	3/4-10	.312	1.750	1.075
1.50	AS-35003	AS-35012	35	.500	2.250	1.900	31572	3/4-10	.312	1.750	1.575
2.00	AS-35004	AS-35014	35	.500	2.250	2.400	31572	3/4-10	.312	1.750	2.075
.75	AS-50001		50	.687	3.000	1.270	46958	1-8			
1.00	AS-50002		50	.687	3.000	1.520	46958	1-8			
1.50	AS-50003	AS-50011	50	.687	3.000	2.020	46958	1-8	.312	2.460	1.513
2.00	AS-50004	AS-50013	50	.687	3.000	2.520	46958	1-8	.312	2.460	2.013



Liner Bushings

HARDNESS: 62+ HRC

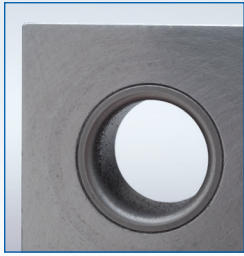

The smart way to protect the dimensional integrity of locating holes on base and fixture plates, indexers and other workholding devices is to use **SpeedLoc™** liner bushings.

Easy to install or remove, **SpeedLoc™** liner bushings are a critical component of the integrated **mPower™** system for creating the highest possible machining accuracy. These bushings are also an inexpensive way to extend even further the operating life of your precision **SpeedLoc™** mounting system investment.

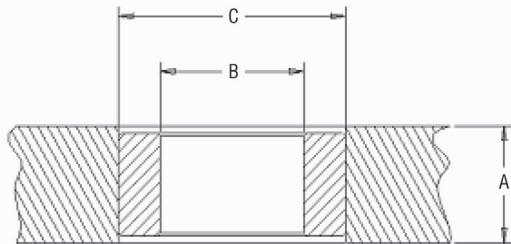

Stepped Liners

One of the great advantages of **SpeedLoc™** is the compact designs and ability to flush mount. **SpeedLoc™** combines both. This is possible due to:

- (1) the exclusive self extracting feature of the locator.
- (2) our unique stepped liner.

The **SpeedLoc™** Stepped Liner allows the compact head

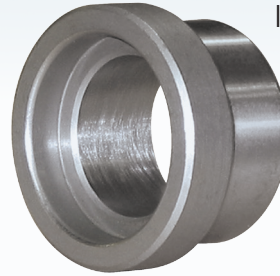

locator to lie flush with the surface of the fixture plate so it does not interfere with the workpiece or other fixture components.

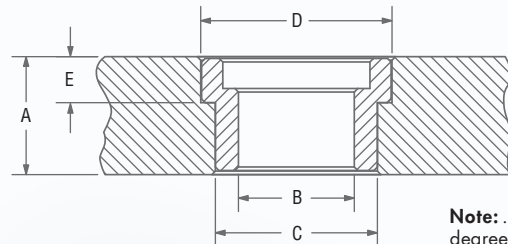

Note: .025 x 45 degree chamfer on all diameters.

FIXTURE PLATE THICKNESS +/- .005 (inch) A	LOCATOR SIZE (mm) B	LINER OVERAL LENGTH (inch) C	STANDARD LINER PART NUMBER	COMPACT LINER PART NUMBER	HEAD THICKNESS (inch) E	HEAD DIAMETER (inch) D	LINER O.D. +.0000/- .0004 (inch) C	PLATE C'BORE DIAMETER ±.005 (inch)	PLATE C'BORE DEPTH +.010/- .005 (inch)
.50	13	.450	AL-13001	AL-13101	.218	.922	.7518	.935	.230
.75	13	.700	AL-13002	AL-13102	.218	.922	.7518	.935	.230
.50	16	.450	AL-16001	AL-16101	.313	1.234	1.0018	1.250	.325
.75	16	.700	AL-16002	AL-16102	.313	1.234	1.0018	1.250	.325
1.00	16	.950	AL-16004	AL-16103	.313	1.234	1.0018	1.250	.325
.75	20	.700	AL-20011	AL-20111	.375	1.359	1.1270	1.375	.390
1.00	20	.950	AL-20012	AL-20112	.375	1.359	1.1270	1.375	.390
1.50	20	1.450	AL-20013	AL-20113	.375	1.359	1.1270	1.375	.390
2.00	20	1.950	AL-20014	AL-20114	.375	1.359	1.1270	1.375	.390
.75	25	.700	AL-25001	AL-25101	.375	1.609	1.3772	1.625	.390
1.00	25	.950	AL-25002	AL-25102	.375	1.609	1.3772	1.625	.390
1.50	25	1.450	AL-25003	AL-25103	.375	1.609	1.3772	1.625	.390
2.00	25	1.950	AL-25004	AL-25104	.375	1.609	1.3772	1.625	.390
.75	30	.700	AL-30001	AL-30101	.375	1.984	1.7523	2.000	.390
1.00	30	.950	AL-30002	AL-30102	.375	1.984	1.7523	2.000	.390
1.50	30	1.450	AL-30003	AL-30103	.375	1.984	1.7523	2.000	.390
2.00	30	1.950	AL-30004	AL-30104	.375	1.984	1.7523	2.000	.390
.75	35	.700	AL-35001				1.7523		
1.00	35	.950	AL-35002	AL-35102	.450	1.984	1.7523	2.000	.465
1.50	35	1.450	AL-35003	AL-35103	.450	1.984	1.7523	2.000	.465
2.00	35	1.950	AL-35004	AL-35104	.450	1.984	1.7523	2.000	.465
.75	50	.700	AL-50001				2.5025		
1.00	50	.950	AL-50002				2.5025		
1.50	50	1.450	AL-50003	AL-50103	.700	3.000	2.5025	3.020	.715
2.00	50	1.950	AL-50004	AL-50104	.700	3.000	2.5025	3.020	.715

Note: when machining fixture plates for feature "C", bore to the listed dimension $-.0006/- .001$ ".

Receivers

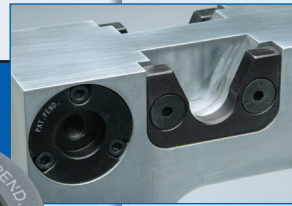
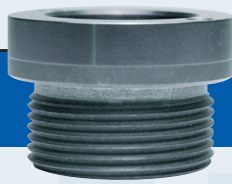

Compact Face Mount Design:
Occupies a small footprint that optimizes subplate space, is easier to install, stronger, and less expensive than face mount receivers.

Standard Face Mount Design:
This receiver is interchangeable with competitive face mount designs providing an advanced retrofit option. For customers with existing

investments in another system. These receivers enable you to take advantage of the speed, precision and easy installation which the **SpeedLoc™** system uniquely offers, without the need to produce new subplates or fixture plates.

Features:

- Precision machined to +/- .0002" tol.
- Permits **SpeedLoc™** repeatability of .0004" or better.

For installation instructions call our engineering department 814-455-8061 extension 233

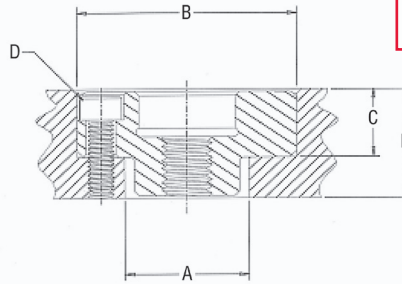
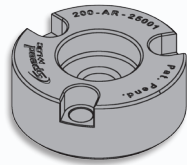

U.S. PATENT 7,686,553

MATERIAL: HEAT TREATED HIGH STRENGTH ALLOY STEEL

STRENGTH: 230,000 + PSI

FINISH: BLACK OXIDE

Stainless and high temperature steels available in all sizes at special request.

Face Mount Receivers

Engineered to allow interchangeability with competitive locking systems.

SHANK DIAMETER (mm)	FACE MOUNT PART NUMBER	RECEIVER O.D. +.0000/- .0004 (inch)	CLEARANCE DRILL (inch) A	PLATE COUNTERBORE +.0004/- .0000 (inch) B	DEPTH +.010/- .005 (inch) C	DRILL AND TAP-THRU SCREW SIZES (inch) D	BOLT CIRCLE DIA. 3 PLACES EQUALLY SPACED (inch)	MIN. PLATE THICKNESS (inch) E
13	AR-13001	1.3750	11/16	1.3754	.469	#8-32 X 1/2	.984	3/4
16	AR-16001	1.4370	13/16	1.4374	.469	#8-32 X 1/2	1.125	3/4
20	AR-20001	1.6873	13/16	1.6877	.637	#10-32 X 3/4	1.362	1
25	AR-25001	2.0623	1	2.0627	.799	1/4-28 X 7/8	1.644	1-1/4
30	AR-30001	2.2654	1-3/16	2.2658	.871	1/4-28 X 1	1.875	1-3/8
35	AR-35001	2.6873	1-9/16	2.6877	.904	5/16-24 X 1	2.178	1-1/2
50	AR-50001	3.4998	2-5/32	3.5002	1.239	3/8-24 X 1-1/4	2.916	2

Face Mount Compact Receivers

Plates can be fully machined from one side.

SHANK DIAMETER (mm)	FACE MOUNT PART NUMBER	RECEIVER O.D. +.0000/- .0004 (inch)	PLATE COUNTERBORE +.0004/- .0000 (inch) A	DEPTH +.010/- .005 (inch) B	MIN. PLATE THICKNESS (inch) C	HOLE THREAD SIZE (INCH) D
13	AR-13005	.9500	.9504	.300	3/4	3/4-16
16	AR-16005	1.0625	1.0629	.300	3/4	7/8-14
20	AR-20005	1.2750	1.2754	.390	1	1-12
25	AR-25005	1.5000	1.5004	.390	1	1-1/4-12
30	AR-30005	1.8125	1.8129	.505	1-1/4	1-1/2-12
35	AR-35005	2.1250	2.1254	.630	1-5/16	1-1/2-12
50	AR-50005	2.750	2.7504	.765	1-3/4	2-12

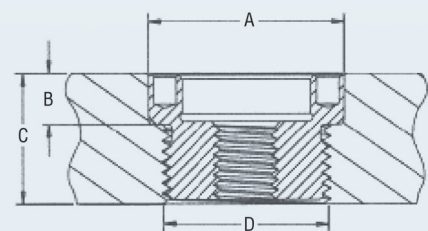

Note:
.025 x 45 degree chamfer on all diameters.



Subplate and Fixture Plates

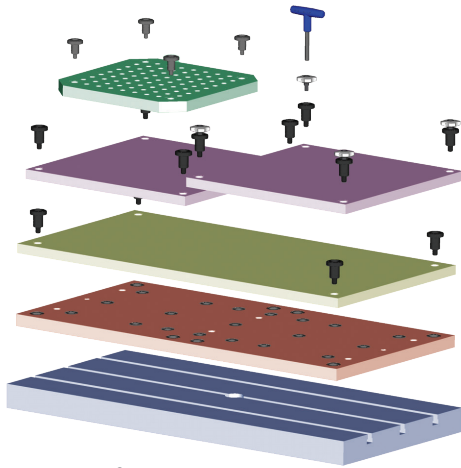

Product overview:

The **SpeedLoc™** system provides a fast, accurate and powerful means of precisely locating and locking two flat surfaces together. While its applications are unlimited, a common use is in machining workholding...connecting fixture plates to subplates.

Build your own plate system in Aluminum (or Steel) or let Modern construct a fully integrated system for you.

Product Line Roundup:

- **Horizontal Machining Center** – Subplates for Tooling Columns 400, 500 and 630mm bases standard.
- **Vertical Machining Center Subplates** – Specify your machine type and typical application(s). We will design a subplate configuration that provides best flexibility for your individual needs. Some common arrays and sizes available.
- **Fixture Plates** – Specify your application needs. (available in both .75" and 1" thickness)

Common configurations include:

Square and Grid Layouts

6" X 6", 8" X 8", 12" X 12", 14" X 14", 16" X 16", 20" X 20"

Other Common Sizes

12" X 16", 12" X 14", 10" X 15", 20" X 40"

Tooling Column Plates

8" X 21", 10" X 24", 10" X 28", 12" X 24", 16" X 28"
(and sizes listed above.)

- **Interlocking Keystone Vice Plates** – For up to 6" straight-body vices.

Features:

- Subplates and Fixture Plates available in Steel and Aluminum.
- Steel—A36 Precision Ground to $\pm .001"$ (.0005" available).
- Aluminum—MIC-6 Ground to $\pm .005"$ or better (.001" available).
- All plates are edge prepped by grinding or milling to $\pm .005"$.
- Subplates come with **SpeedLoc™** receivers installed.

System Components:

Subplate – Secures to a machine table and remains fixed. These aluminum or steel plates contain SpeedLoc™ Receivers at desired locations to attach fixture plates. Machine tables outfitted with SpeedLoc™ Receivers do not require Subplates.

Fixture Plates – Can be designed in a number of sizes and shapes to best fit the application. They are secured by inserting a SpeedLoc™ Locator through lined or unlined holes and into the SpeedLoc™ Receiver installed in the subplate or machine table.

Liner – Hardened alloy steel bushing press fit into a fixture plate hole to provide wear resistance and precision with repeated use. The stepped liner configuration allows for flush mounting with the compact head SpeedLoc™ locators.

Locator – A precision fastener system that locates and clamps fixture plates to subplates or machine tables by insertion into a SpeedLoc™ Receiver pocket.

Receiver – Installed into subplates, tooling columns, or machine tables to accept SpeedLoc™ Locators.



It's time to rethink the age-old T-Slot table

Sure T-Slot tables offer infinite fixture positioning flexibility in the "Y" axis. But that's it. Creating "open-setups" are painfully slow (translation: costly downtime) and there's no way to accurately re-position, fixtures, vises or other workholding devices.

SpeedLoc[™] Subplates are the foundation of the **SpeedLoc**[™] Quick Change Fixture System for vertical and horizontal machining centers.

Example: Part # SPS-2040-STD Subplate
This configuration is designed for VMC's with a 40" x 20" table travel.

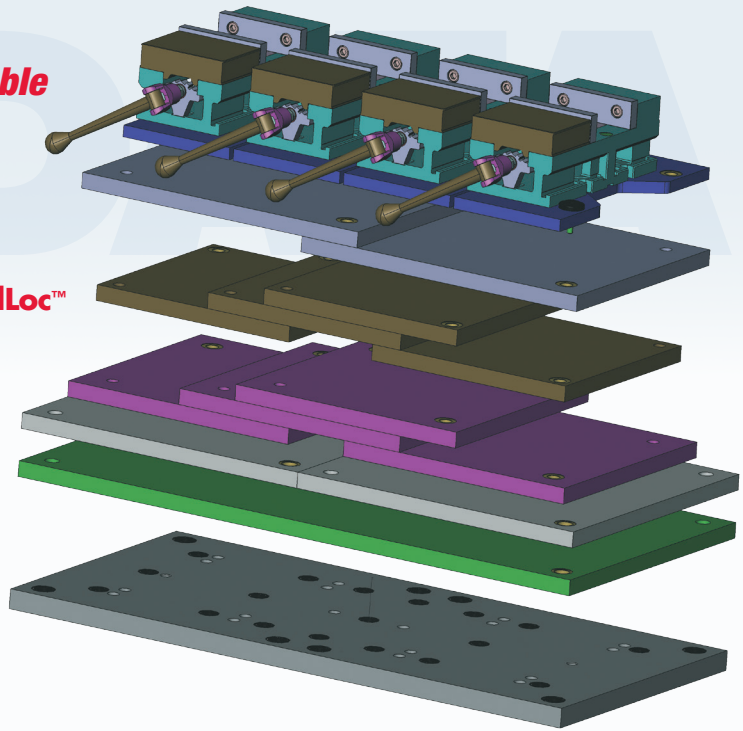

Specifications

- **A36 Steel** – Surface ground to +/- .001"
- **Edges** – Milled or ground to +/- .005"
- **Thickness** – 1.25"
- **Weight** – 385 lbs.
- **Machine Table Configuration** – 3 or 5 T-Slots
- **Compact Head SpeedLoc**[™] Receivers
Installed – (8) 25mm, (18) 20mm

Custom designed receiver layouts are our specialty. To discuss your specific needs, call Modern Industries engineering department at 814-455-8061 Ext. 233.

Possible Fixture Plate Configurations, Part No: SPS-2040-STD

Color	Layer	Description
GRAY	Base	SpeedLoc [™] subplate with (8) 25mm, (18) 20mm receivers
GREEN	2	(1) 20" x 40" Fixture plate
SILVER	3	(2) 20" x 20" Fixture plates
PURPLE	4	(2) 16" x 16" Fixture plates (Four different positions available)
BROWN	5	(2) 14" x 14" Fixture plates (Four different positions available)
LIGHT BLUE	6	(1) 20" x 16" Fixture plate (Two different positions available)
DARK BLUE	7	(4) Keystone vise plates

How does the **SpeedLoc**[™] system compare to the competition?...

- **Superior Design...**all **SpeedLoc**[™] components are truly "Better by Design" and possess substantial advantages in strength, installation, performance and ease of extraction over any other system...plus it's FAST.
- **The Right Solution for you...**we'll never push an "off-the-shelf" system when it's not the best solution. Modern encourages a standardized approach designed to best fit your specific needs. We offer engineering support for installations of all sizes and complexities.
- **Exceptional Subplate Quality...**our subplates are held to a closer tolerance than those of the competition. The milled edges and extra-finished surfaces of **SpeedLoc**[™] sub and fixture plates help users achieve the highest possible machining accuracy.
- **Your Success is our Success...**our goal is helping you succeed and prosper...that's what will make you a repeat customer. Talk to an **MPower**[™] engineer anytime about your needs at 814-455-8061 x233 or e-mail engineering@mpwer.com.

Mod LOC™

Modular Tooling Columns



Product Overview:

In designing the unique **ModLoc™** modular tooling columns, **mPower™** engineers borrowed heavily from the principles of advanced structural engineering to produce a tooling column where the fixture plates essentially become the structure and strength of the system.

Rigid and strong, yet substantially lighter than cast columns, **ModLoc™** tooling columns assemble quickly and feature an open architecture that is ideal for systems requiring hydraulic or electrical control systems.

ModLoc™ tooling columns take full advantage of the incredible precision and efficiency of the **SpeedLoc™** system to cut fixture plate setups to just seconds.

Building a
tooling column

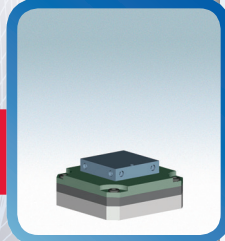
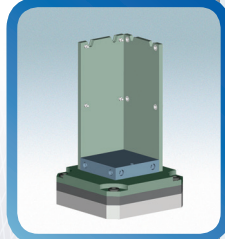
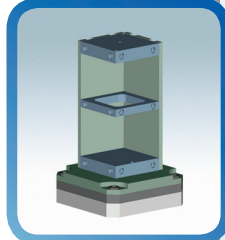
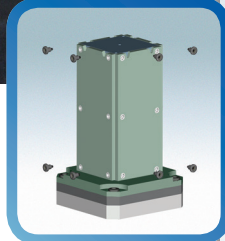

Features:

- Designed to utilize the revolutionary **SpeedLoc™** precision mounting system for fast, precise assembly.
- "Kit" construction permits extremely flexible configuration.
- "Open" design permits hydraulic and electrical access to indexers and other devices as needed.
- Popular sizes and shapes available off-the-shelf or made-to-order with short lead times.
- The relatively light weight of **mPower™** modular tombstones permit HMC machining turntables to operate at optimum efficiency with reduced machine wear and tear.
- Each unit is uniquely constructed in serialized sets using **mPower's™** proprietary manufacturing process.
- Docking system available as optional equipment.
- Patented: U.S. Patent No. 7,083,166

ModLoc™ Modular Tooling Columns vs. Solid Tombstones...

Consider the Advantages:

- 1. Overall Strength** – Strength and deflection resistance of **mPower's™** modular tooling column compares favorably to that of a solid cast tombstone.
- 2. Assembly Time** – A modular tooling column can be assembled in minutes versus the lead times associated with cast tombstones.
- 3. Purchase Cost** – A modular tooling column generally provides a significant cost savings versus solid cast tombstones.
- 4. Fixturing Flexibility** – Modular tooling columns offer design flexibility compared to cast tombstones.
- 5. Hydraulic & Electrical Systems** – The "open" design of modular tooling columns readily accepts hydraulic & electrical systems to actuate or control process applications...not possible with a solid tombstone.

ModLoc™ tooling columns are available in a wide range of special configurations to help optimize the use of your machining center's functional envelope.

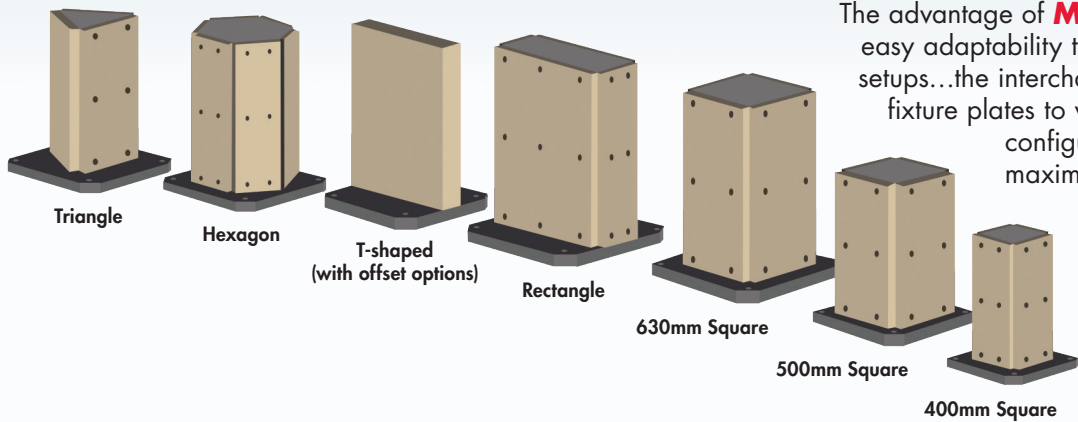
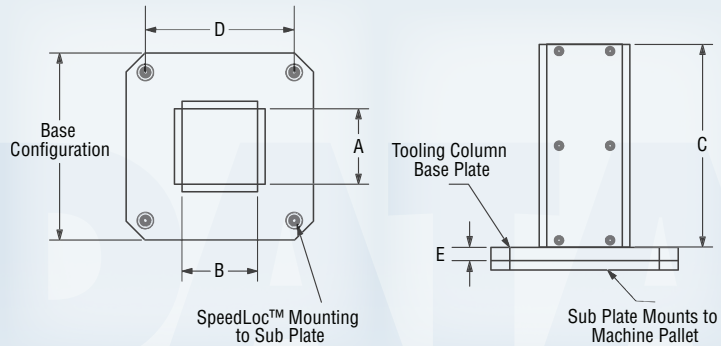

The advantage of ModLoc™ is its easy adaptability to a variety of setups...the interchangeability of fixture plates to various shape configurations helps maximize your ROI.

Square Tooling Columns

SQUARE COLUMN PART NUMBER STEEL (ALUMINUM)	FACE SIZE (inch) A X B	AVAILABLE HEIGHTS 2" INCREMENTS (inch) C	SPEEDLOC RECEIVER SIZE (mm)	BASE CONFIGURATION* (listed in inches under columns D & E)					
				400mm		500mm		630mm	
				D	E	D	E	D	E
CS-408XX (CA-408XX)	8 X 8	14 THRU 24 21" Standard Kit	25	12	1.5	16	1.5	20	1.5
CS-410XX (CA-410XX)	10 X 10	14 THRU 28 24" Standard Kit	25	12	1.5	16	1.5	20	1.5
CS-412XX (CA-412XX)	12 X 12	14 THRU 32 24" Standard Kit	25	-	-	16	1.5	20	1.5
CS-416XX (CA-416XX)	16 X 16	14 THRU 36 28" Standard Kit	25	-	-	16	1.5	20	1.5

ModLoc™ Square Column Weights

Column	Column Weight (lbs.)	Weight with Base (lbs.)		
		400mm	500mm	630mm
CA-40821	111	144	164	214
CS-40821	121	218	277	414
CA-41024	159	192	212	262
CS-41025	327	423	483	620
CA-41628	319	-	371	422
SC-41628	642	-	797	935

Note: when ordering, last 2 digits of the part number specifies the column height in inches.
* Configured for SpeedLoc™ subplates or customized for your machine if subplates are not used.

Rectangular Tooling Columns

RECTANGULAR PART NUMBER STEEL (ALUMINUM)	STANDARD SIZE THICK X WIDTH (inch) A X B**	AVAILABLE HEIGHTS (inch) C	SPEEDLOC RECEIVER SIZE (mm)	BASE CONFIGURATION (listed in inches under columns D & E)					
				400mm		500mm		630mm	
				D	E	D	E	D	E
CS-615XX (CA-615XX)	6 X 15	14 THRU 24 21" Standard Kit	25	12	1.5	16	1.5	20	1.5
CS-820XX (CA-820XX)	8 X 20	14 THRU 28 24" Standard Kit	25	12	1.5	16	1.5	20	1.5
CS-1024XX (CA-1024XX)	10 X 24	14 THRU 36 28" Standard Kit	25	12	1.5	16	1.5	20	1.5

Note: when ordering, last 2 digits of the part number specifies the column height in inches.
** A wide range of size configuration available through custom order.

SpinTM LOC

Indexers

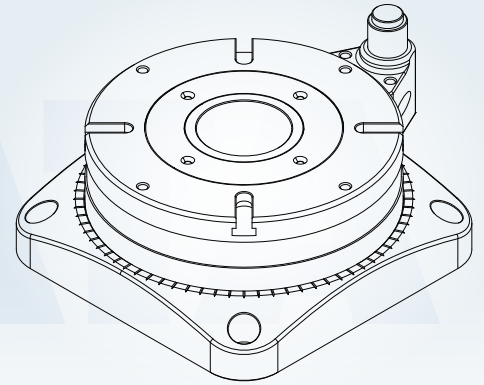
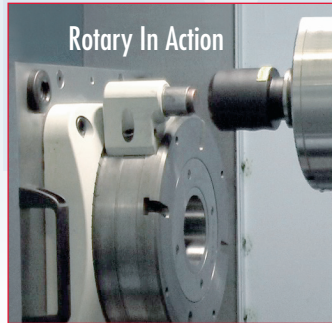
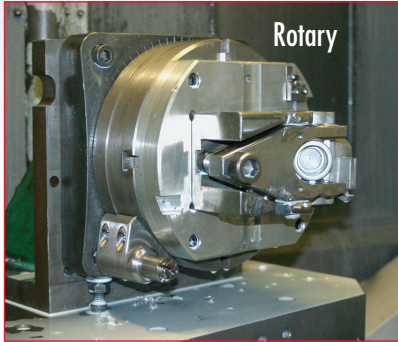

Specifications

Rotary Indexer for Horizontal Machining Centers

U.S. PATENT NUMBER: 6,619,895

PART NUMBER: SLIC-H010

FACE DIAMETER: 10"

INDEXING INCREMENTS: 5° STANDARD

HEIGHT: 4.75"

WEIGHT: 85 lbs.

FORCE NEEDED TO ACTUATE INDEXING POST: 312 lbs.

BASE DIMENSION: 11" x 11"

ACTUATION: ROTARY USING TOOL SPINDLE
(Program a 6.031" radius)

Features:

- High accuracy spindle actuation using a Hirth gear coupling design. Will not drift under load like some electric indexers.
- A full 360° range of motion.
- 5° index movement accurate to +/- 15 seconds standard.
- Extremely fast indexing, 1–3 seconds.
- Designed specifically for use with the **SpeedLocTM** precision mounting system and Trunnion Kit.
- Rugged construction.
- Custom gear sets quoted on request.

Applications:

1. Horizontal machines
2. Vertical machines
3. **SpeedLocTM** Trunnion Kit

SpinLocTM Indexers

Product overview:

MPower'sTM **SpinLocTM** indexers provide an economical way to expand the capabilities of your existing vertical and horizontal machining centers with 4th or 5th axis accessibility to the work piece. **SpinLoc'sTM** unique, patented rotary indexer delivers mechanically actuated 5° movement without costly external power supplies or hydraulic pumps.

SpinLoc'sTM vertical pump indexers are also available for VMC/HMC applications and for use on the exclusive **SpeedLocTM** Trunnion Kit. No other system compares to the range of features, benefits and operating advantages of **SpinLocTM**. Consider how these exclusive indexers can positively impact your competitive edge...

- **Simplicity** – **SpinLocTM** indexers are mechanically actuated by the machine, eliminating the need for electronic or hydraulic systems.
- **Faster Set-Up & Integration** – **SpinLocTM** indexers can be integrated into fixturing systems much faster than powered systems.
- **HMC & VMC Actuation Systems** – Rotary actuated indexing systems are available for horizontal and vertical applications.
- **Reliability and Precision** – Designed with features like Hirth gear couplings and tempered alloy steel components, you can count on **SpinLocTM** to deliver accurate and repeatable performance.
- **Ideally Suited** – for pallet applications.

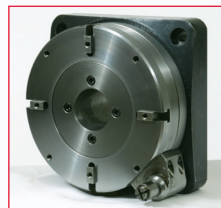

Trunnion Kit

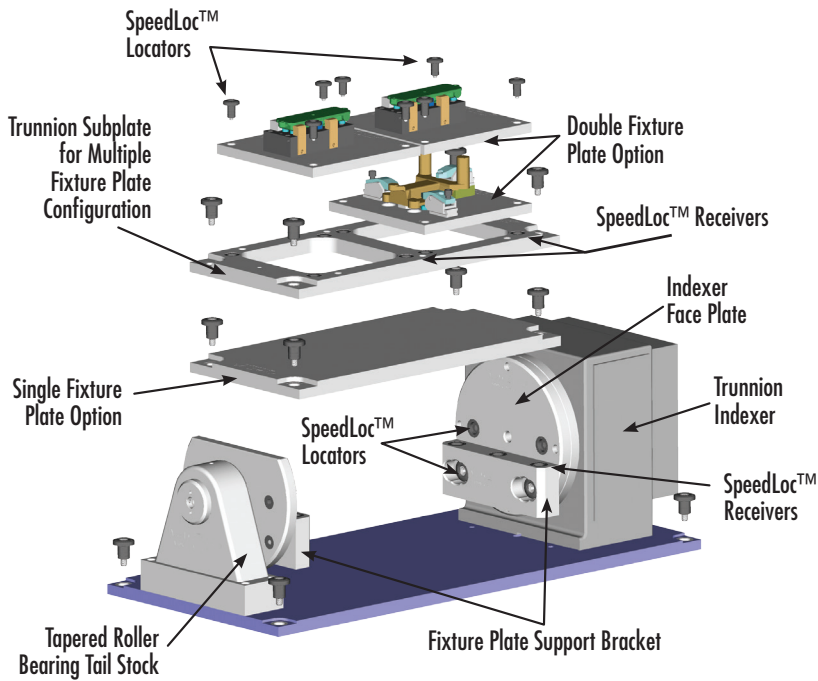

Product overview:

Nowhere are the **SpeedLoc™** and **SpinLoc™** systems put to better use than as the building block of **mPower's™** Trunnion Kit for Vertical Machining Centers. Use a **SpinLoc™** plunger-type indexer (or other suitable indexer) with our Trunnion to add 4th axis capability to your VMC and eliminate wasteful work piece handling. The Trunnion's flexible design gives fixture builders the ultimate tool to create powerfully productive workholding systems.

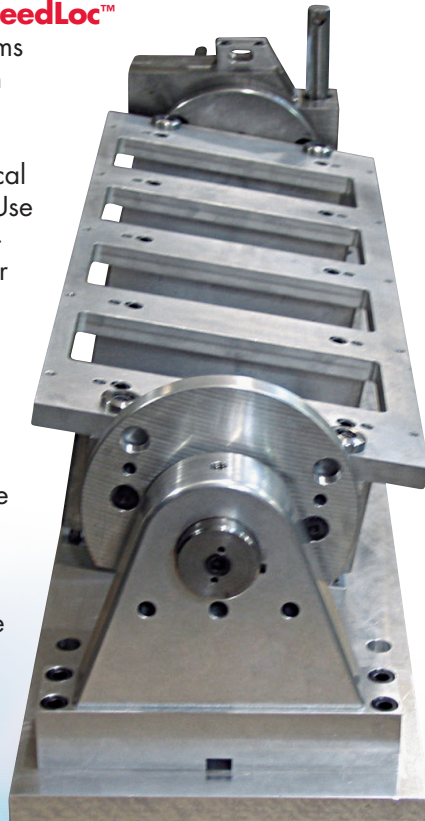

Features:

- Rigid construction.
- Tail stock with sealed tapered roller bearings from Timken™.
- Modular design...allows for fast reconfiguration and fixture changeovers.
- Uses **SpeedLoc™** Mounting/Fastening System
- Indexing provided by **SpinLoc™** plunger type indexer—or any other mechanical or powered indexer.

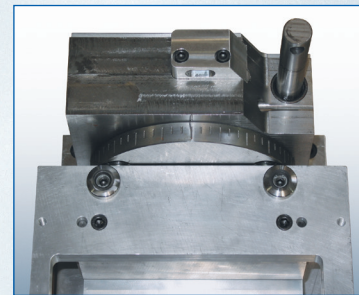

mPower™ Work Supports

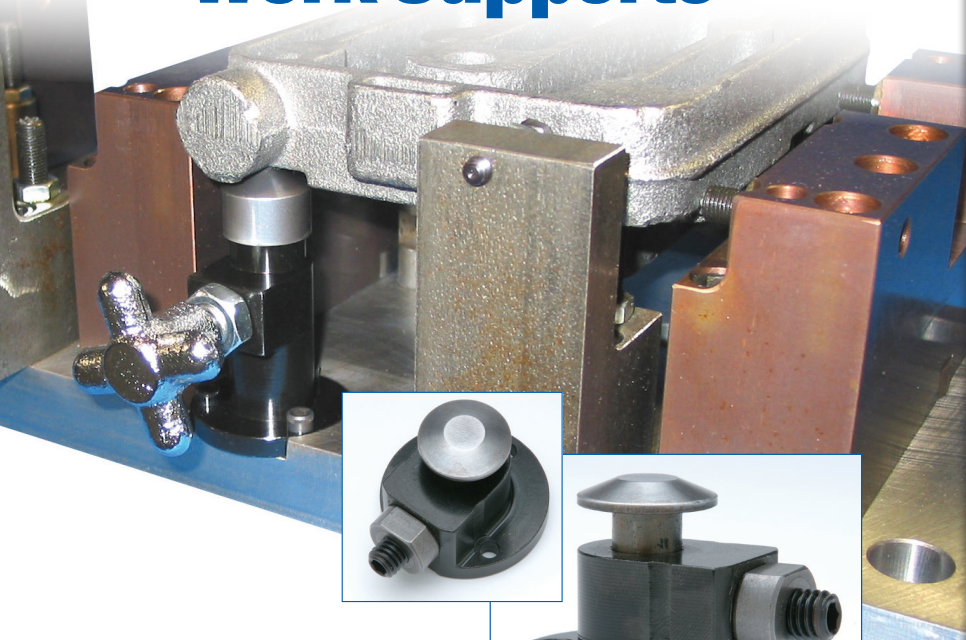

Work Supports

Modern's toolmakers support over 100 CNC machines.

After struggling with over priced, poor performing work supports, **mPower™** design engineers came up with a better product. We believe the **mPower™** work support is superior to other manual work stops on the market. Why?

- Up to 40% lower price than competitive models.
- Hardened tool steel body provides superior strength.
- Will not disassemble during operation.
- Lowest profile available.

PART NUMBER	BOLT CIRCLE PATTERN (inch)	MAXIMUM LOAD CAPACITY (lbs.)	HEIGHT UNLOADED	HEIGHT FULLY COMPRESSED	FIXED SPRING LOAD (lbs.)	NOTES
2805600	1.5	3000	1.467	1.233	6.5	With Cap
2805602	1.5	3000	1.412	1.162	6.5	No Cap
2805601	1.5	3500	3.267	2.933	6.5	With Cap & Knob
2805603	1.5	3500	2.956	2.632	6.5	No Cap
2805604	1.5	3500	3.267	2.933	6.5	No Knob
2805605	1.5	3500	2.956	2.632	6.5	No Cap & No Knob



Features:

- Low profile design, modular construction.
- Will not compress after clamping.
- 1.5" Bolt circle hole pattern.
- Swivel and V-notch style available.
- Spring pressure fixed at 6.5# max.
- Produced from hardened tool steel.
- Flange mounting for #10 SHCS
- Custom sizes, bolt pattern and head configurations available.

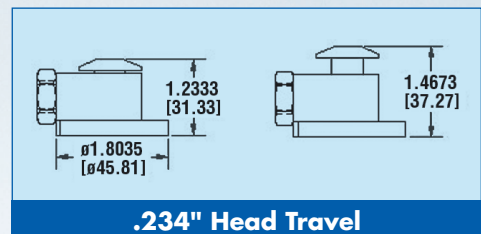
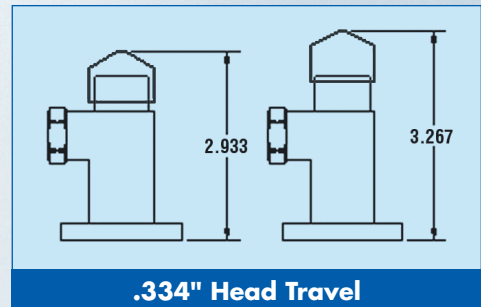

Docking Hardware

Originally designed to integrate with the ModLoc™ T-column, the docking mechanism can be installed on any conventional tombstone. Include Modloc™ Docking in your next tombstone purchase.

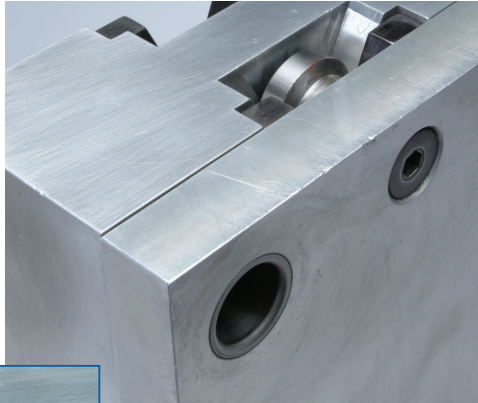

Patent pending

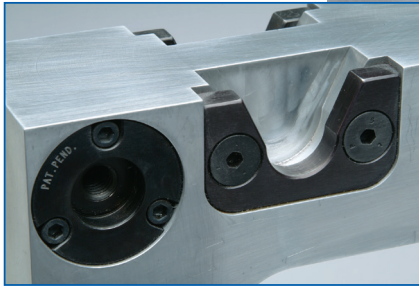

ORDER PART NUMBER	DESCRIPTION
DH-10001	Plate with Screws
DH-10003	Stud with Screws (1" Plate)
DH-10005	Kit Includes Both DH-10001 & DH-10003
DH-10007	Stud with Screws (3/4" Plate)

Handles & Knobs

Product overview:

The convenient, ergonomically enhanced quick knob creates a positive 360° gripping surface that enables users to quickly hand tighten SpeedLoc™ Locators into their mating receiver pocket with either left hand, right hand or both. Conventional T-handle Allen wrenches also available.



SPEEDLOC™ LOCATOR SHANK DIAMETER (mm)	T-HANDLE PART NUMBER	QUICK KNOB PART NUMBER
13	FA-13001	FA-13010
16	FA-16001	FA-16010
20	FA-20001	FA-20010
25	FA-25001	FA-25010
30	FA-30001	FA-30010
35	FA-35001	FA-35010
50	FA-50001	FA-50010

No where is the **mPower™** mandate to develop faster, smarter ways to operate workholding equipment more evident than with the innovative **ModLoc™** docking system.

Docking ports are installed into the top of each face of a tooling column (or into the top **ModLoc™** manifold bracket) and mate with positioning studs mounted to fixture plates.

Operators can then simply "hang" the fixture plates in place and lock them with the **SpeedLoc™** precision mounting system.

Order **ModLoc™** tooling columns factory equipped with this unique docking system and reduce the time it takes to make fixture plate changes to a couple minutes...or install them on your existing cast tombstones.

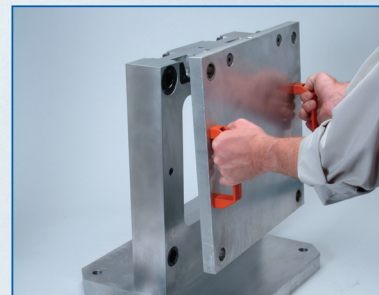

Hydraulic Products



Modern Industries is a leading manufacturer of custom engineered industrial shock absorbers for a wide variety of process applications.



Whether your process application or product requires one of the shock absorbers listed above or something special, contact us today for complete details, application assistance or pricing/availability.

Control Speed
Dampen Natural Frequency
Smoothly Stop Moving Loads
Reduce Structural Fatigue

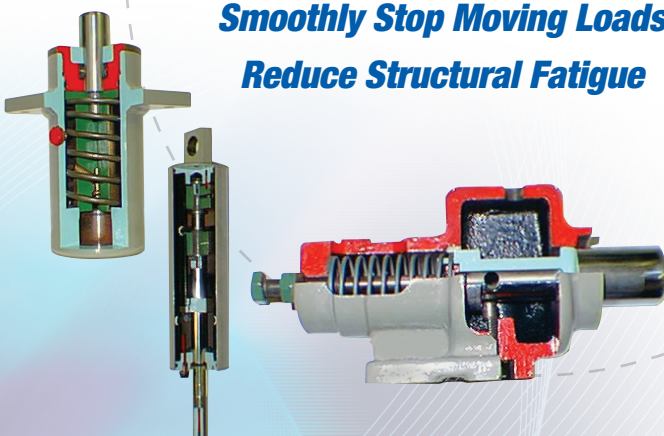

The range of styles and types of shock absorbers available include...

Series 10 Dashpot Shock Absorber

- Capacity to 1,500 in lbs.
- single action.
- spring return.
- hardened plunger.

Series 20 Linear Type Shock Absorber

- Capacity to 30,000 in lbs.
- single action or double action.
- orifice specs to customer needs.
- optional stroke.

Series 30 Bumper Shock

- Capacity to 60,000 in lbs.
- single action.
- pre-engineered orifice.
- spring return.
- high energy unit.

Series 40 Adjustable Bumper

- Capacity to 6,000 in lbs.
- easy field adjustment.
- hardened impact cap.

Series 50/70 Rotary Type Shock Absorber

- Capacity to 5,000 in lbs.
- single or double action.
- independent orifice specs.
- 60° operating range.
- 360° choice in operating arm location.

Series 60 Adjustable Rotary Shock Absorber

- Capacity to 5,000 in lbs.
- single action in either direction or double action.
- 100° angular travel.
- 360° choice in arm position.

mpowerTM
 PRODUCTS BY MODERN INDUSTRIES

www.mpower.com

Additional **MODERN** Services Include...

Heat Treating

Looking for an experienced, quality-driven source for heat treating? Give Modern's Commercial Heat Treating Group a call. We are one of the largest, most diverse heat treaters in the Midwest. Servicing an incredibly diverse range of customers...like you.

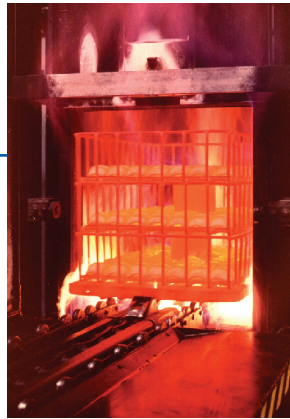

In addition to conventional processes like Quench and Temper, Normalizing and Annealing...Modern offers metallurgical expertise in:

- Ferritic Nitrocarburizing
- Deep Case Carburizing
- Deep Cryogenics
- Vacuum Treatments
- Induction Hardening
- Carbonitriding
- CNC Straightening
- Nitriding

Add it up... and the advantages are clear. Let Modern Industries quote on your next heat treating job.

Laboratory Testing

When it comes to exacting laboratory testing & evaluation, Modern Industries, Laboratory Testing Group is your one-call, total capabilities provider.

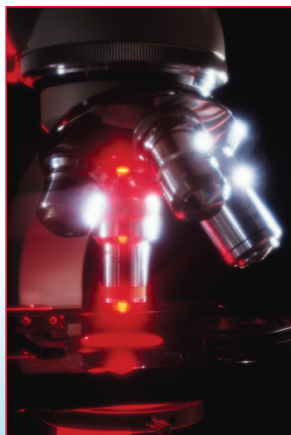

Established in 1987, this operation represents the latest technology in materials analysis/evaluation and industrial testing.



Whatever your metallurgical testing, failure analysis and materials evaluation needs, you can count on Modern's Laboratory Testing Group to deliver. ISO-9001, ISO-17025, TS-16949 and Nadcap certified and accredited by major industry and independent trade groups.

A broad list of services includes...

- Metallurgical Testing.
- Physical & Mechanical Properties Testing.
- Materials Engineering and Consulting.
- Failure Analysis.
- Production Non-Destructive Testing.
- Environmental and IH Testing.
- Chemical Analysis.
(Extensive Spectroscopic Facilities)

[**m**aximize The Power.]

- [✓] Faster setups...in just minutes
- [✓] Optimize fixturing flexibility
- [✓] Significantly improve machining output
- [✓] Reduce costs



Quick Change Fixture/Mounting System



Modular Tooling Columns



Indexing Systems



www.mpwer.com





The Company behind the **mPOWER™** line.

PRODUCTS BY MODERN INDUSTRIES

Modern Industries, Inc., headquartered in Erie, PA, was founded in 1946. Over the years, we have grown to include a diverse range of manufacturing, product and service offerings. Our knowledge of machining and the "day-in-day-out" concerns over how to produce jobs faster and less costly, without sacri-

ficing quality, makes us keenly sensitive to the needs of other manufacturers.

Those concerns were the motivating force for producing the **mPOWER™** line of productivity enhancing/time reducing production tools for industry and specifically, machining center operators. This is a product line that will

be dynamically growing, so make a point of regularly visiting www.mpwer.com.

You can also get information on the complete line of **mPOWER™** products at your local authorized **mPOWER™** distributor. To locate your nearest distributor, visit www.mpwer.com or call toll free at 877-588-7255, Ext. 222.



MODERN INDUSTRIES, INC.
Geared to Industry Since 1946

613 West 11th Street ▶ Erie, PA 16512-0399
Ph: 814-455-8061 Ext. 233 ▶ Fax: 814-453-4382
www.mpwer.com

2/14 R50



MODERN INDUSTRIES, INC.
Geared to Industry Since 1946

613 West 11th Street
Erie, PA 16512-0399
Ph: 814-455-8061 Ext. 233
Fax: 814-453-4382
www.mpwer.com